

Autor Pictogramas: Sergio Palau- Procedencia: <http://catedu.es/arasaad>

Licencia: CC (BY-NC-SA)

2010

Método de Lectoescritura



Autora: Juana María Bayo
<http://maestradeal.blogspot.com>

16/01/2010

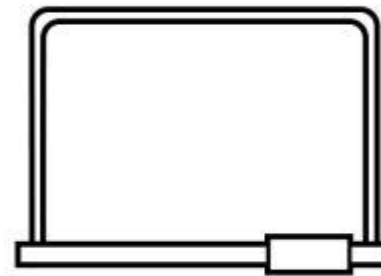
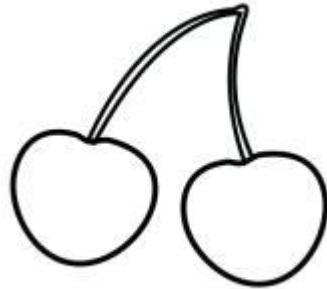

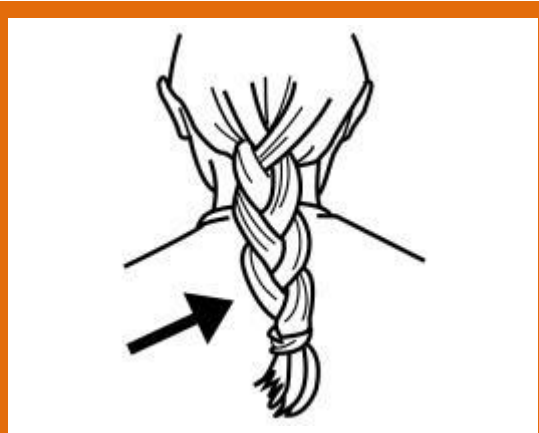

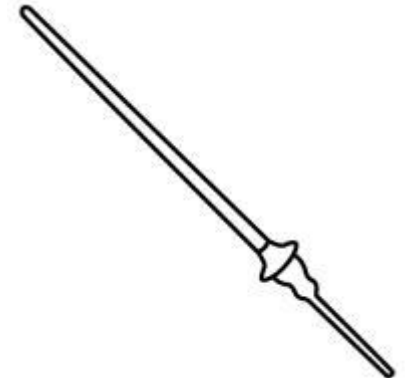
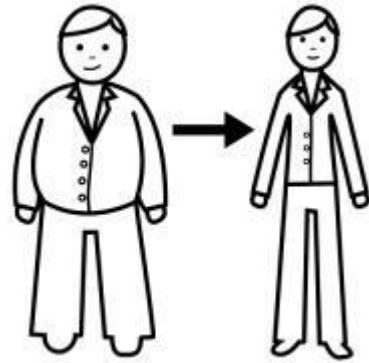
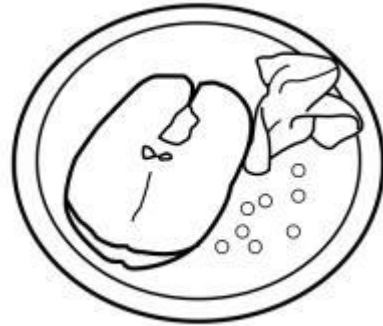

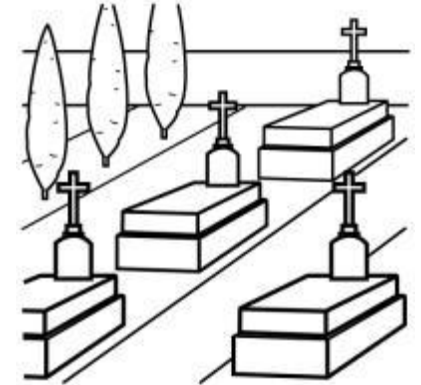
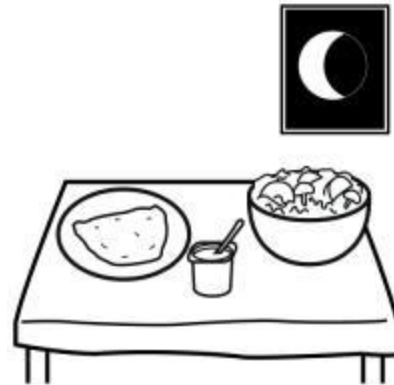
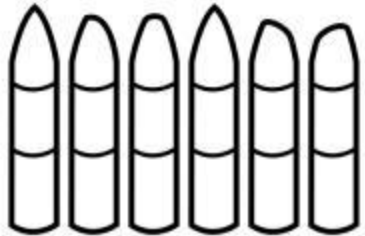
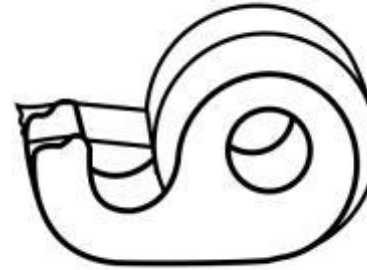
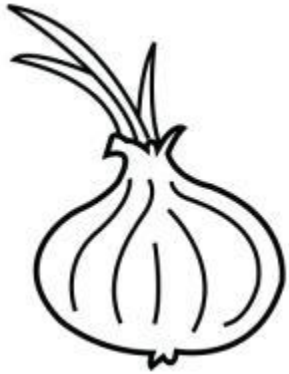
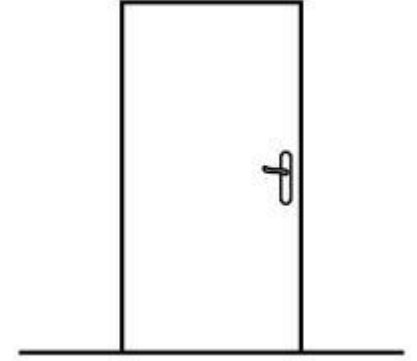
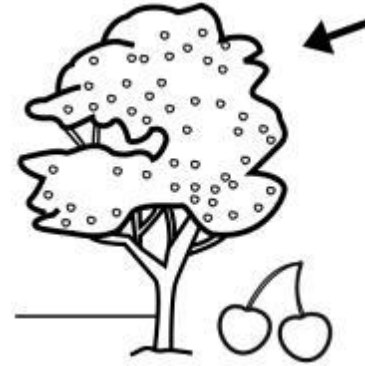
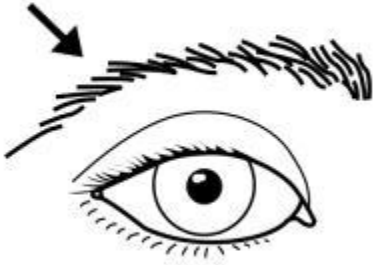

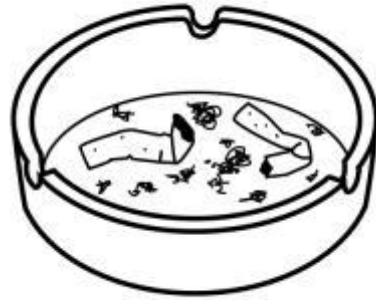
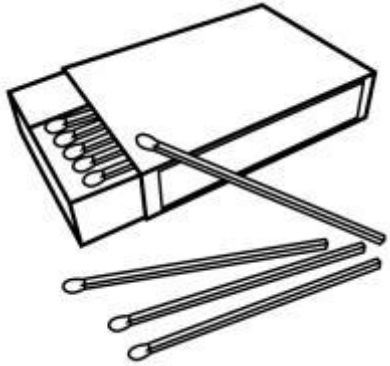

0

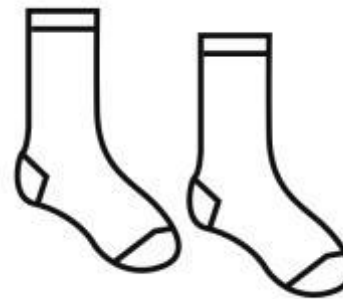
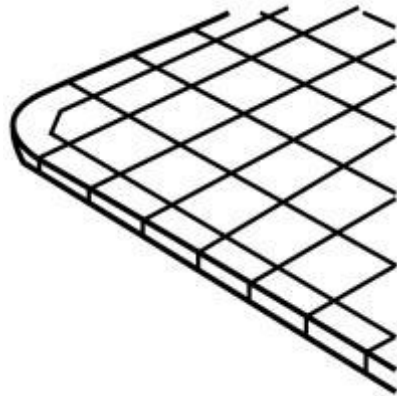
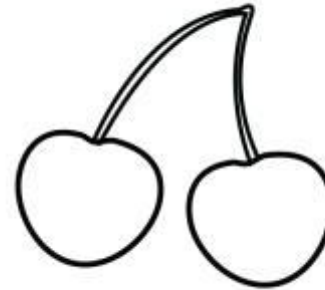

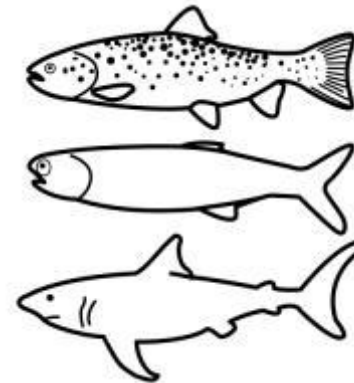
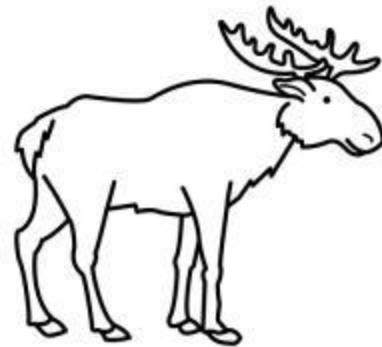
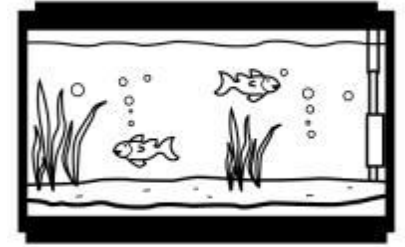
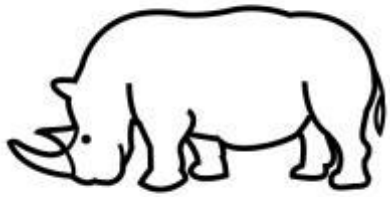

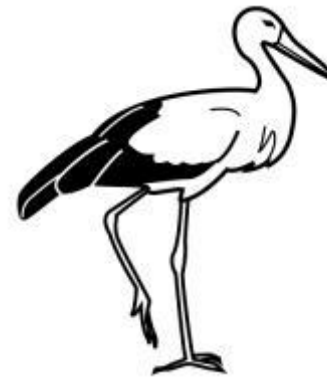
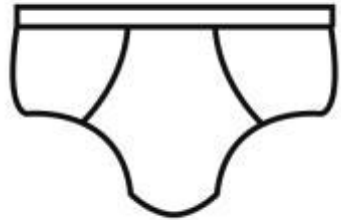

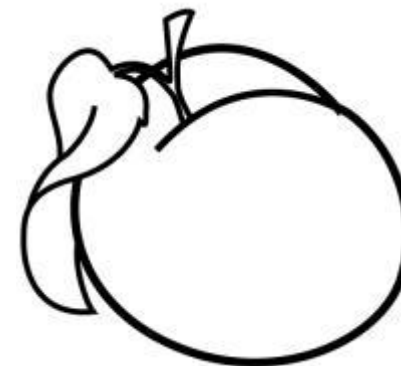
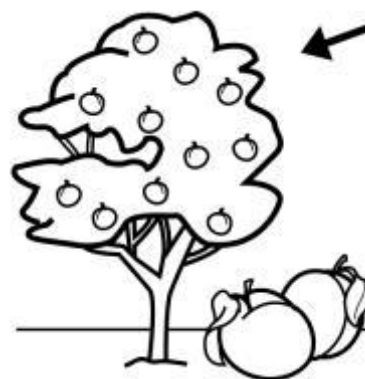
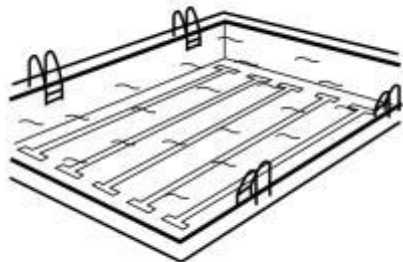

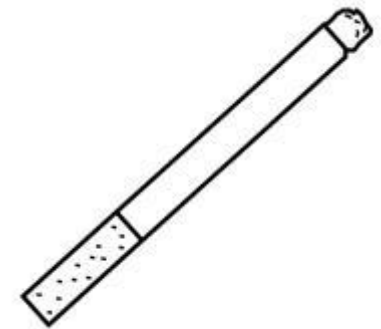
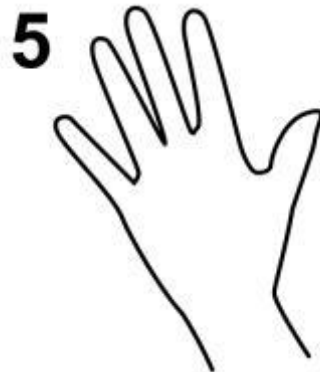
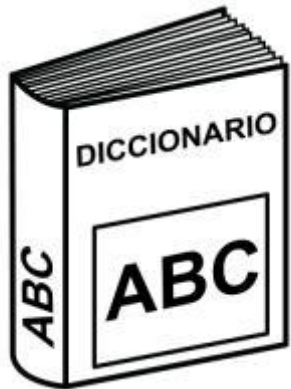
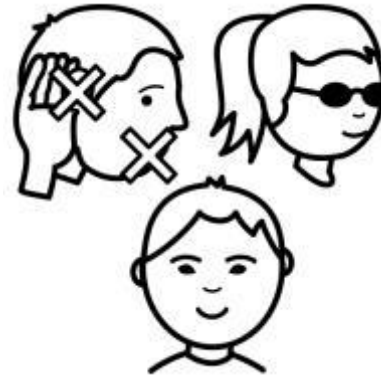
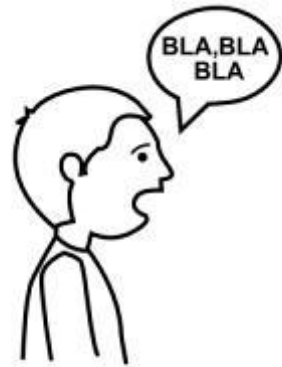
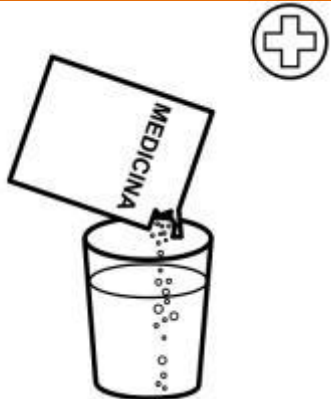
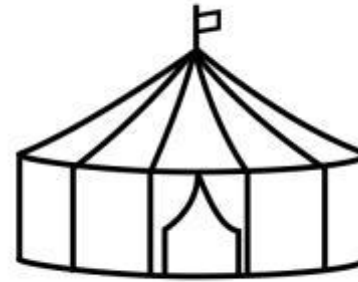
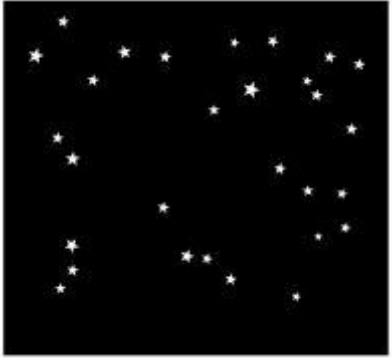

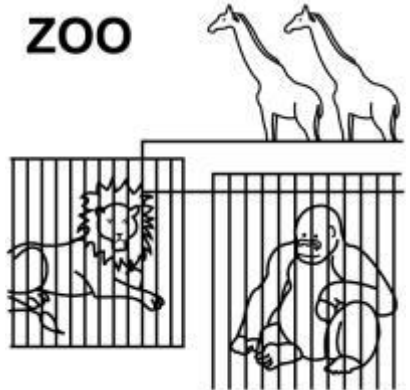
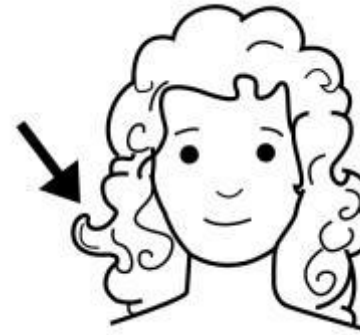
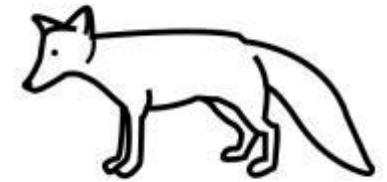
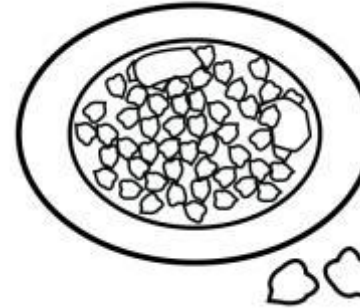
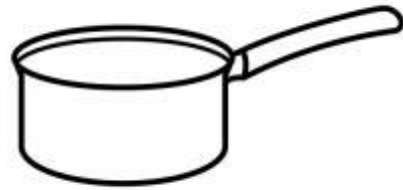
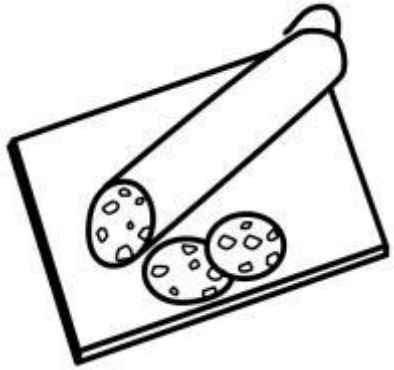

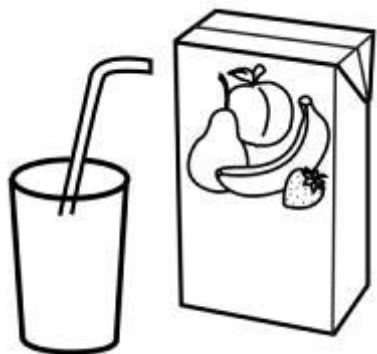
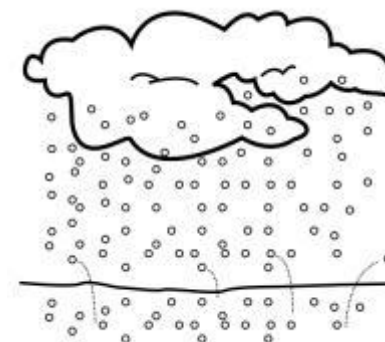
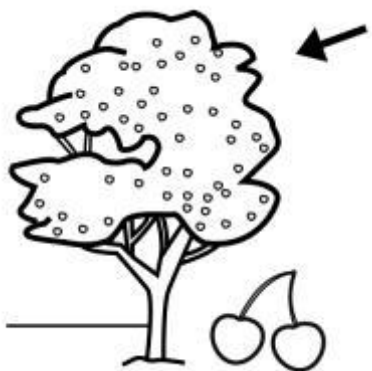

ZAPATOS	ZAPATERO	ZAPATERÍA	ZAPATILLAS
CAZADORA	CEREZAS	TAZA	MANZANA
LONGANIZA	PIZZA	PIZARRA	PINZAS
AZADA	CAZADOR	LECHUZA	TRENZA
BAUTIZAR	GRANIZAR	MANZANO	TIZAS
DISFRAZAR	ABRAZAR	PLAZA	EMBARAZADA

CHOZA	MERLUZA	CARROZA	CALABAZA
CAPERUZA	ADELGAZAR	LANZAR	CERVEZA
TENAZAS	ZANAHORIA	HORTALIZAS	LANZA
CEJA	CERRADURA	CEREZO	CERRAR
CEBOLLA	CEBRA	CELO	CEPILLAR
CERAS	CENA	CENAR	CEMENTERIO

CERILLAS	CENICERO	CERILLAS	CERDITO
CERO	CESTA	CEREZAS	CEPILLO
LAPICERO	ACERA	CALCETINES	ACEITE
RINOCERONTE	PINCEL	LUCES	PECERA
CARNICERÍA	CARNICERO	PRINCESA	BALONCESTO
ENCENDER	ALCE	PECES	NACER

CALZONCILLO	BICI	TRICICLO	CICLISTA
COCINERO	COCINA	COCINAR	MORCILLA
CISNE	CIERVO	CIGÜEÑA	CIGALA
MURCIÉLAGO	PISCINA	CIRUELO	CIRUELA
MURCIÉLAGO	CIEGA	ANCIANO	PRÍNCIPE
CIUDAD	DICIEMBRE	CIRCO	GRACIAS

MEDICINA	DECIR	DISCAPACIDAD	ANUNCIO
DICCIONARIO	CINCO	CONducIR	CIGARRO
CHORIZO	CAZO	GARBANZOS	ZORRO
BUZO	LAZO	RIZO	BAUTIZO
PUÑETAZO	MARZO	DESCALZO	ZOO
CEREZO	MAZORCA	POZO	GRANIZO

PEREZOSO	SAZONAR	AZUCARAR	ZUMBIDO
ZUMO	PEZUÑA	CABEZUDOS	ANZUELO